

TONNEAU FITTING INSTRUCTION

Ford Next Gen Ranger Dual Cab

Without Sport Bar And Headboard

July 2022 - Current

Part number: 11460

Package includes

1 X Tonneau cover	20 x Rivets
1 x Tonneau Support Bar	18 x Rope Buttons
2 x Bar Bracket with Clamp	1 x Lock Bracket
1 x Fitting Instructions	1 x Rust Inhibitor
	18 x Anti Abrasive Discs

1. TONNEAU COVER FITTING

NOTE Read entire instructions prior to start.

1.1 BASIC TOOL REQUIRED

Drill, 4.5mm Drill Bit, Rivet Gun, Non-Permanent Pen and 5mm hex key

1.2 TONNEAU COVER INSTALLATION PROCEDURE

1. Fit the Support Bar

- (a) Slide and attach the Patented Adjustable Bar Bracket as shown in **Figure 1** using M8 Bolt with washer and Side Clamps.
- (b) Engage the adjustable bar bracket between low and medium height.
- (c) Fit the bracket on the middle of the tub. Using 5mm hex to tighten 8mm bolt. **Figure 2**
- (d) Rotate the Support Bar 90° and push into the top of the Adjustable Bar Bracket. Ensure it is seated firmly into place by pushing lightly in the centre of the Support Bar.
- (e) Fit the front of the Tonneau Cover to the front of the Ute tub placing the Plastic Retainers (Fitted on the Tonneau Cover) on to the Metal Lip on the Body, between the cabin and the Ute Body. (Behind rear windscreen).

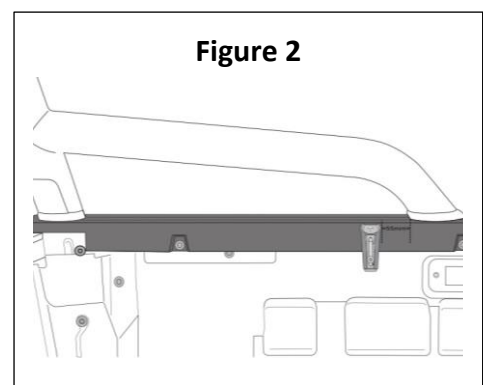
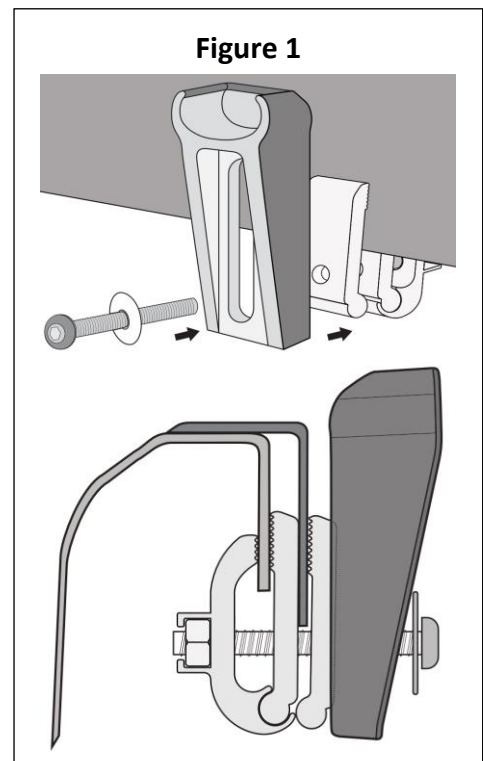

2. Fit buttons to the tailgate

- (a) Measure 500mm up from the bottom edge of the tailgate and mark button positions in line with each of the bunjis. **Figure 3**
- (b) Working from the centre out: drill holes, apply rust inhibitor and rivet buttons into place. Attach bunjis to buttons as they are riveted in place.

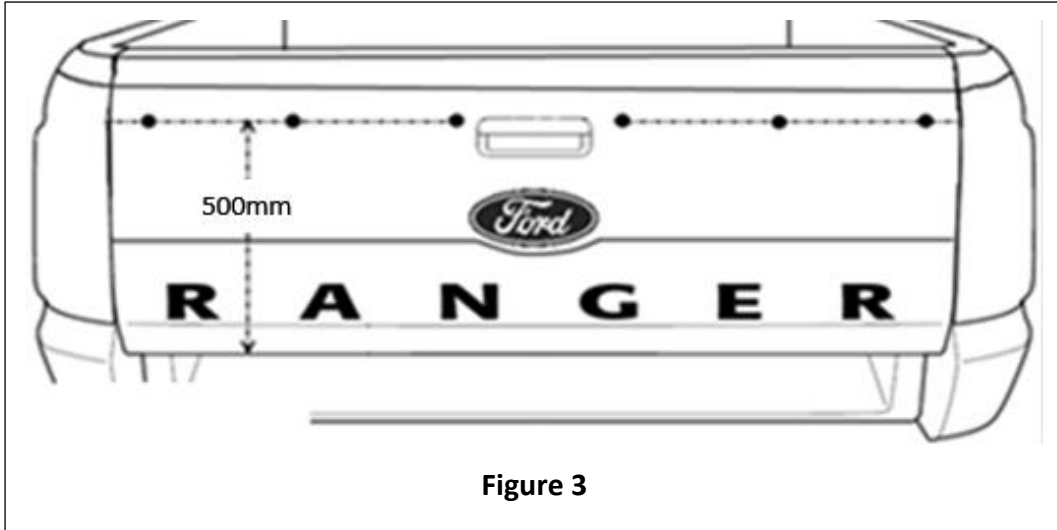
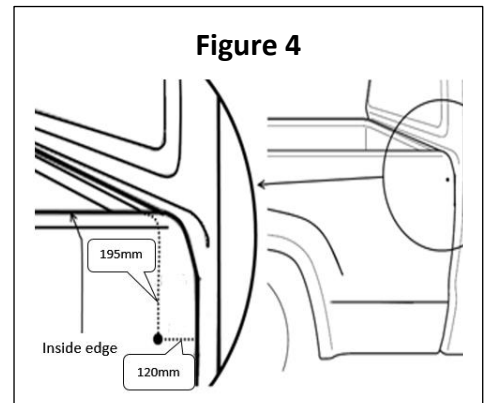

Figure 3

3. Fit buttons to side of Tub.

- (a) Measure down **195mm** from the inside edge of the tub, and back **120mm** from the front outside edge of the tub and mark. **This is the position of the front button.**

Figure 4



- (b) Measure down **165mm** from the inside edge of the tub, in line with the Rear-Side Bunji and mark. **See Figure 5**

Figure 5

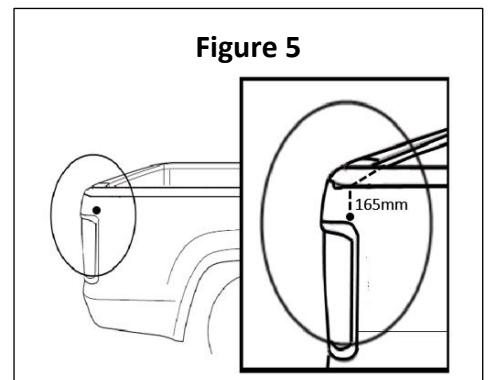

- (c) Using a straight edge or string line, draw a line between front mark & rear mark as shown in **Figure 6**.

Figure 6

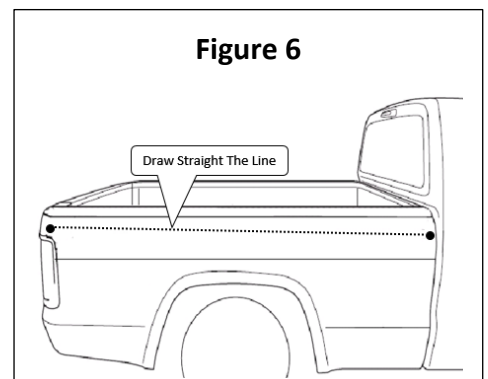

- (d) Fit the **front button only** to the vehicle by drilling a 4mm hole at the front mark then apply rust inhibitor and rivet button into place.

- (e) Work from the rear most bunjis towards the front, alternating from side to side. Line up the rear most bunji loop (#1) on the drivers side of the vehicle and make a mark on the line drawn in step “d”. Drill hole, apply rust inhibitor and rivet button into place as shown in **Figure 7**

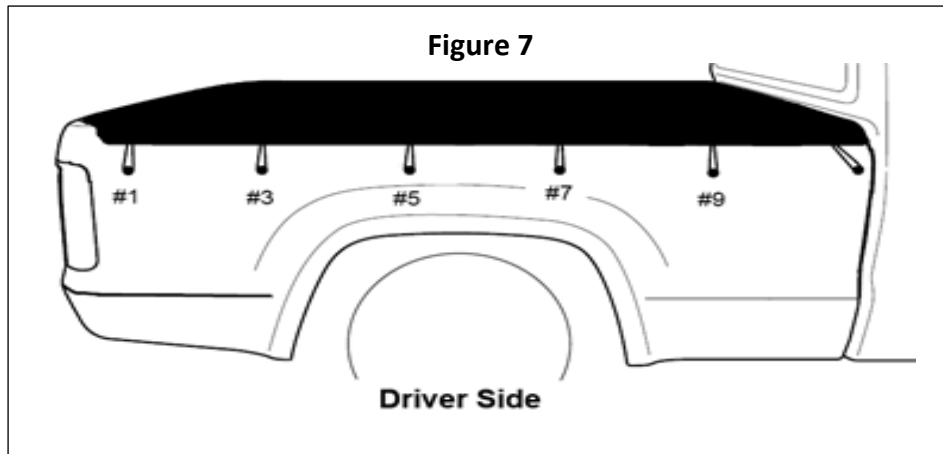

- (f) Repeat step “e” for the rear most bunji loop (#2) on the passenger side of the vehicle.

- (g) Fit remaining 8 bunjis following the sequence as in **Figures 7 & 8**

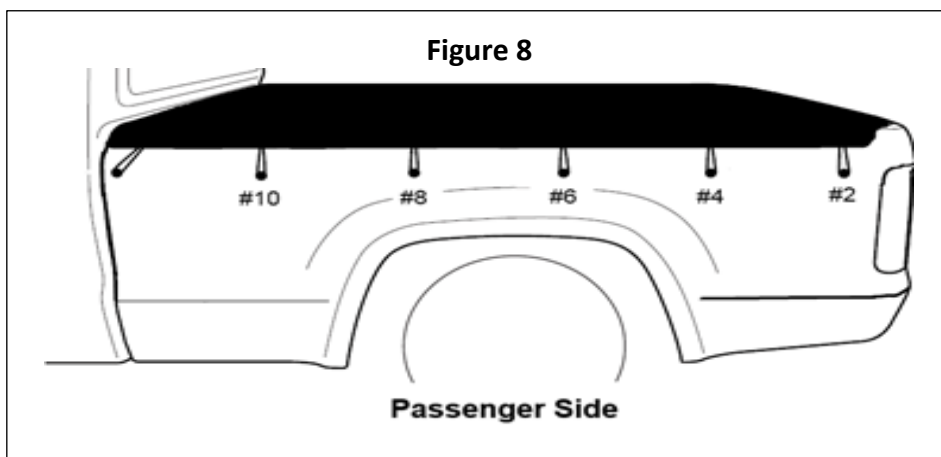

4. To Fit Anti-Abrasive Discs: Firstly clean the area behind each bunji head with a clean rag and methylated sprits. Then attach the anti-abrasive discs centrally behind each bunji head.

Note: Ensure you work from side to side to maintain tension across the tonneau cover.

2. TONNO LOCK

The Tonno Lock is now a standard feature included with all Tuff Tonneaus. The Tonno Lock is situated at the front of the tonneau cover, so as not to impede the accessibility of the Tuff Tonneau.

Fitting the lock is simple and only requires a small attachment on the inside edge of the tub behind the cab. Together with a padlock, it provides you with an extremely effective theft deterrent. The Tonno

Lock is designed to suit all utes and prevent thieves stealing your Tuff Tonneau, so you can continue to rely on the Tuff Tonneaus' name to give you what you want in a tonneau cover.

2.1 BASIC TOOLS REQUIRED

Rivet gun, Drill, Torch, and Marking Pencil/Pen.

You will need to buy a small Padlock- make sure the padlock will go through the hole on the Tonno lock.

2.2 TONNO LOCK CONTENTS

- 2 X 4MM Aluminium rivets
- 1 x Tonno Lock bracket

2.3 FITTING TONNO LOCK

1. Attach the lock bracket to the bracket on the tonneau with your padlock, and fit the tarp.
2. Getting under the tarp with a torch, place the lock bracket against the body and mark holes with a pen.
3. Remove tonneau and drill the marks with a 4 mm drill bit, place the lock bracket in position and rivet.

3. WARRANTY AND FEEDBACK

Please register your warranty details online at:

QR Code:



Website Link:

<http://www.tto.com.au/en-au/warranty.html>

Please complete our 2 minute feedback section as we strive to constantly improve for our customers.