

TONNEAU FITTING INSTRUCTION

FORD F100 F150 Long Wheel Base

1985-1989

Part number: 11444

Package includes

1 X Tonneau cover	1 X Tonneau lock
1 x Fitting Instructions	36 x Rivets
2 x Long Support Bars	9 x LTD Posts Small
2 x Bar sheath	4 x Bar Brackets
	24 x Buttons
	24 x Anti Abrasive Discs

1. TONNEAU COVER FITTING

NOTE Read entire instructions prior to start.

1.1 BASIC TOOL REQUIRED

Drill, 4mm Drill Bit, Rivet Gun, and Marking Pencil / Pen

1.2 TONNEAU COVER INSTALLATION PROCEDURE

1. Place tonneau on the front of the tray as shown in Diagram A.
2. Drill through clips using a 3.2mm drill bit and screw in LTD posts as you go along, in the order shown in Diagram A.
3. To fit bar brackets measure 818mm back from the inside front edge for the first one then 1637mm from the inside front edge for the second one and place them as shown in diagram A. (5mm down from top edge of tub) drill using 4mm drill bit and rivet using two rivets for each Bar Bracket. Install support bar according to supplied instructions.
4. To Fit Anti-Abrasive Discs: Firstly clean the area behind each bunji head with a clean rag and methylated sprits. Then attach the anti-abrasive discs centrally behind each bunji head.

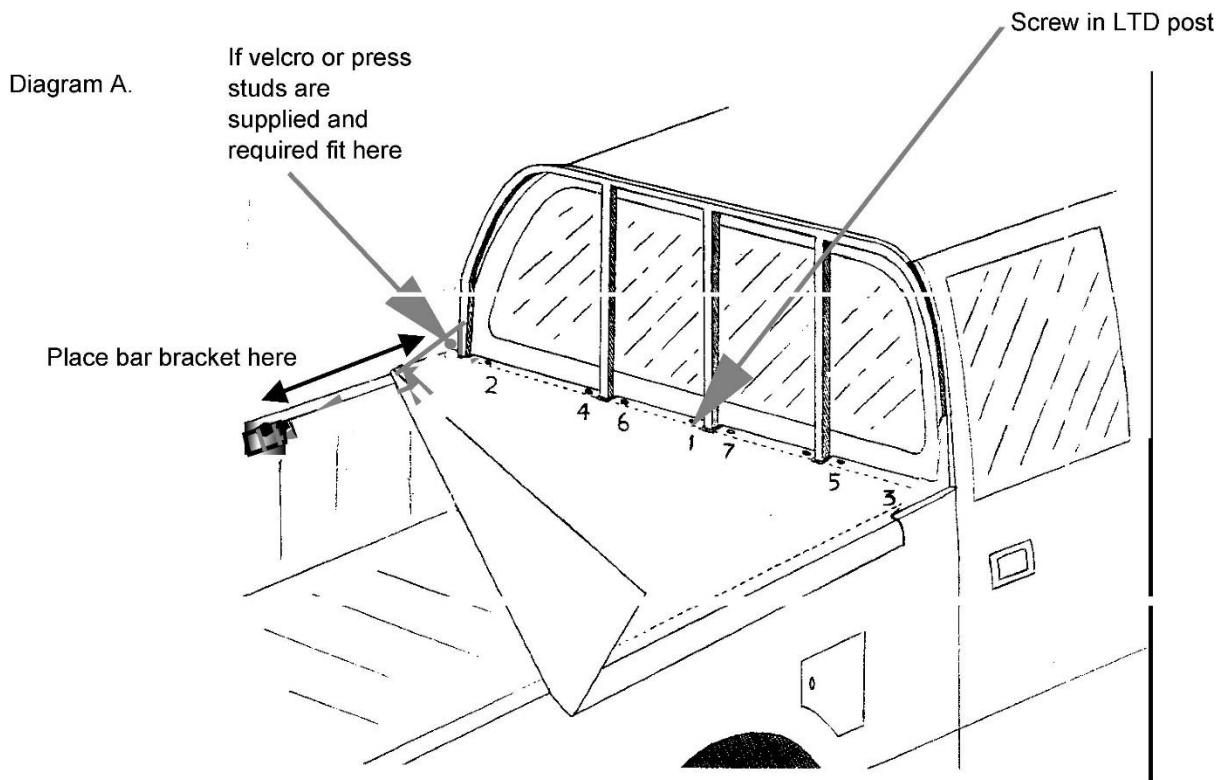

Line up with each loop individually

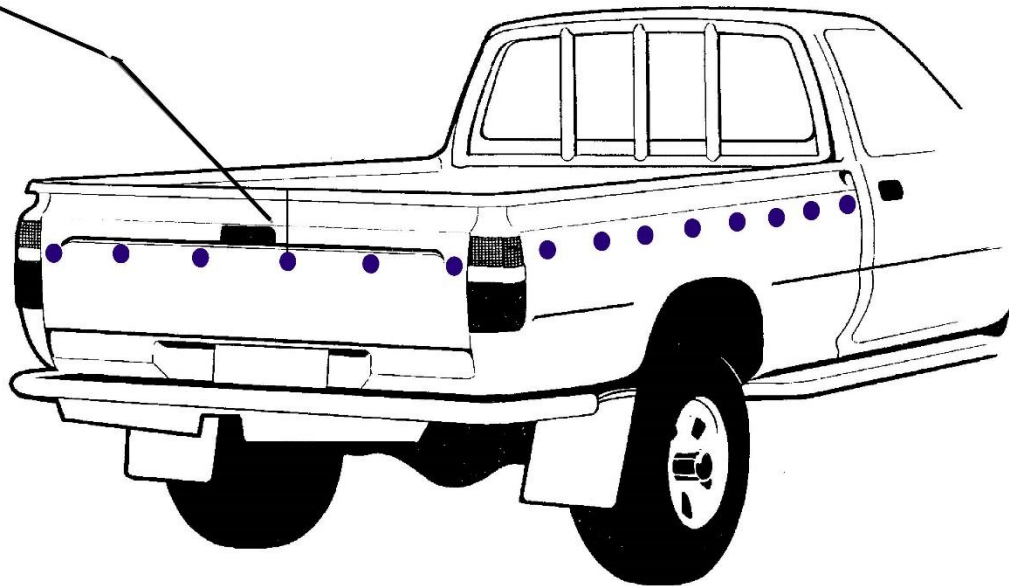

2. TONNO LOCK

The Tonno Lock is now a standard feature included with all Tuff Tonneaus. The Tonno Lock is situated at the front of the tonneau cover, so as not to impede the accessibility of the Tuff Tonneau.

Fitting the lock is simple and only requires a small attachment on the inside edge of the tub behind the cab.

Together with a padlock, it provides you with an

extremely effective theft deterrent. The Tonno Lock is

designed to suit all utes and prevent thieves stealing your Tuff Tonneau, so you can continue to rely on the Tuff Tonneaus' name to give you what you want in a tonneau cover.



2.1 BASIC TOOL REQUIRED

Rivet gun, Drill, Torch, and Marking Pencil/Pen.

You will need to buy a small Padlock- make sure the padlock will go through the hole on the Tonno lock.

2.2 TONNO LOCK CONTENTS

- 2 X 4MM Aluminium rivets
- 1 x Tonno Lock bracket

2.3 FITTING TONNO LOCK

1. Attach the black lock bracket to the bracket on the tonneau with your padlock, and fit the tarp.
2. Getting under the tarp with a torch, place the lock bracket against the body and mark holes with a pen.

Remove tonneau and drill the marks with a 4 mm drill bit, place the lock bracket in position and rivet.

3. WARRANTY AND FEEDBACK

Please register your warranty details online at:

QR Code:



Website Link:

<http://www.tto.com.au/en-au/warranty.html>

Please complete our 2 minute feedback section as we strive to constantly improve for our customers.

Your Tuff Tonneau is now ready for work.